

FRAME SECTION B-B

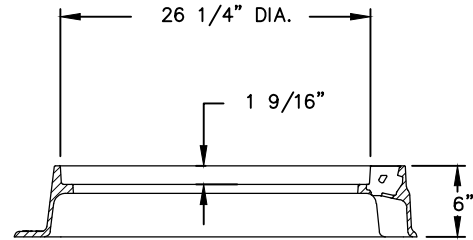

FRAME SECTION A-A

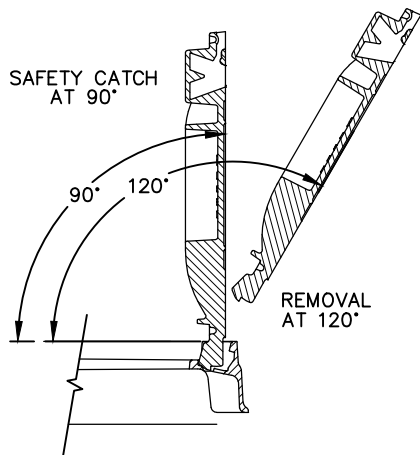

HINGE POSITIONS

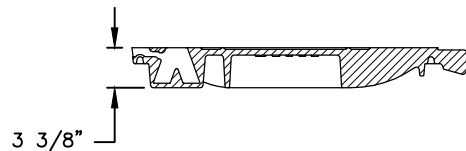

COVER SECTION

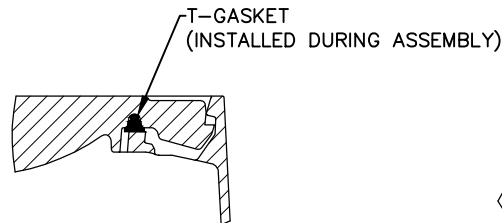

HINGE & GASKET VIEW

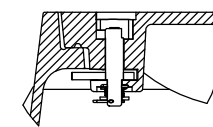

CAM LOCK VIEW

NOTE:

1. MANHOLE FRAME AND COVER SHALL BE EAST JORDAN IRON WORKS ERGO ASSEMBLY, PART NUMBER 001040105L01.
2. FOR PRIVATE MANHOLES, FRAME AND COVER SHALL BE EAST JORDAN IRON WORKS ERGO ASSEMBLY, PART NUMBER 00104043L01. MANHOLE LID TO SAY "SEWER". MANHOLE LID NOT TO INCLUDE NUD LOGO OR NAME.

MANHOLE LOCKING FRAME AND COVER

NOT TO SCALE

DETAIL APPROVALS
EDITOR TMC
MANAGER SJD

NORTHSHORE UTILITY DISTRICT
 2024 STANDARD SEWER DETAILS

5

LAST UPDATED
 FEBRUARY 2020