

PLAN

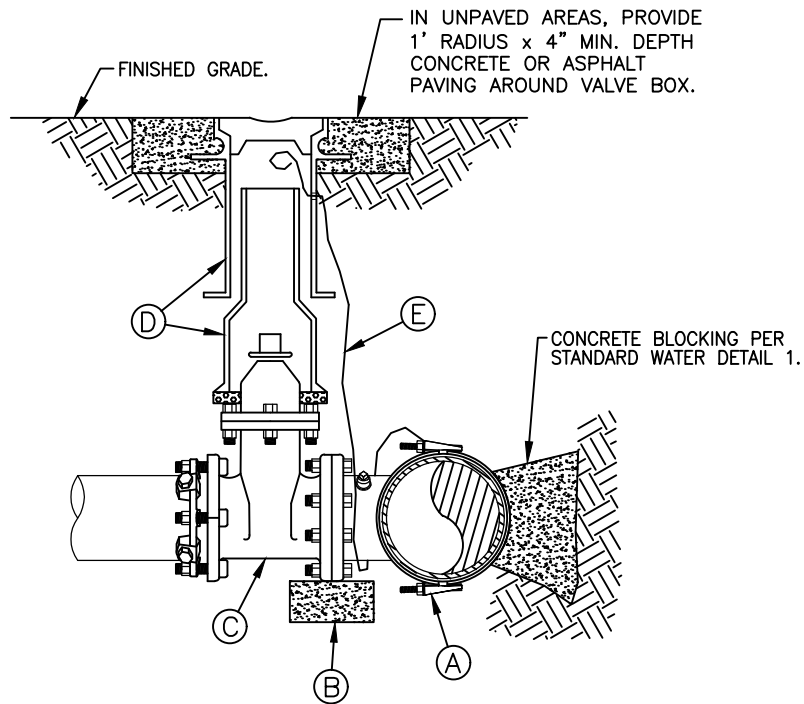

PROFILE

**MATERIALS LIST**

**ITEM DESCRIPTION**

- (A) STAINLESS STEEL TAPPING TEE WITH DI FLANGE; ROMAC SST, FORD FAST, OR JCM 462.
- (B) PRECAST 4"x8"x16" CONCRETE BLOCK.
- (C) R.W. GATE VALVE, F.L.xR.J.: SHALL BE PER THE SPECIFICATIONS. FOR VALVE OPERATING NUT DEPTHS, SEE STANDARD WATER DETAIL #11
- (D) TWO-PIECE VALVE BOX AND ETHAFOAM RING PER THE SPECIFICATIONS AND STANDARD WATER DETAIL #11.
- (E) TRACER WIRE: BLUE 14 GAUGE COPPER, CONTINUOUS, SOLID CORE, POLYETHYLENE INSULATED PER THE SPECIFICATIONS. CONTINUOUS FROM MAINLINE.

**TAPPING TEE AND GATE VALVE**

NOT TO SCALE

**DETAIL APPROVALS**

**EDITOR** TMC

**MANAGER** SJD

**NORTHSHORE UTILITY DISTRICT**

**2023 STANDARD WATER DETAILS**

**20**

LAST UPDATED  
JANUARY 2023