

GROUT ADJUSTING RINGS INSIDE, OUTSIDE AND BETWEEN. GROUT UNDER CASTING. INSIDE GROUT SHALL HAVE A SMOOTH BROOM FINISH.

MANHOLE FRAME AND COVER PER THE STANDARD SEWER DETAIL #5. LOCATE AS SHOWN ON PLAN.

IN UNPAVED AREAS, OR AS SHOWN ON THE PLANS, PROVIDE AN ASPHALT OR CONCRETE RING AROUND THE MANHOLE FRAME, 12" WIDE AND 6" THICK. CONCRETE RING SHALL HAVE A BROOM/TROWEL FINISH

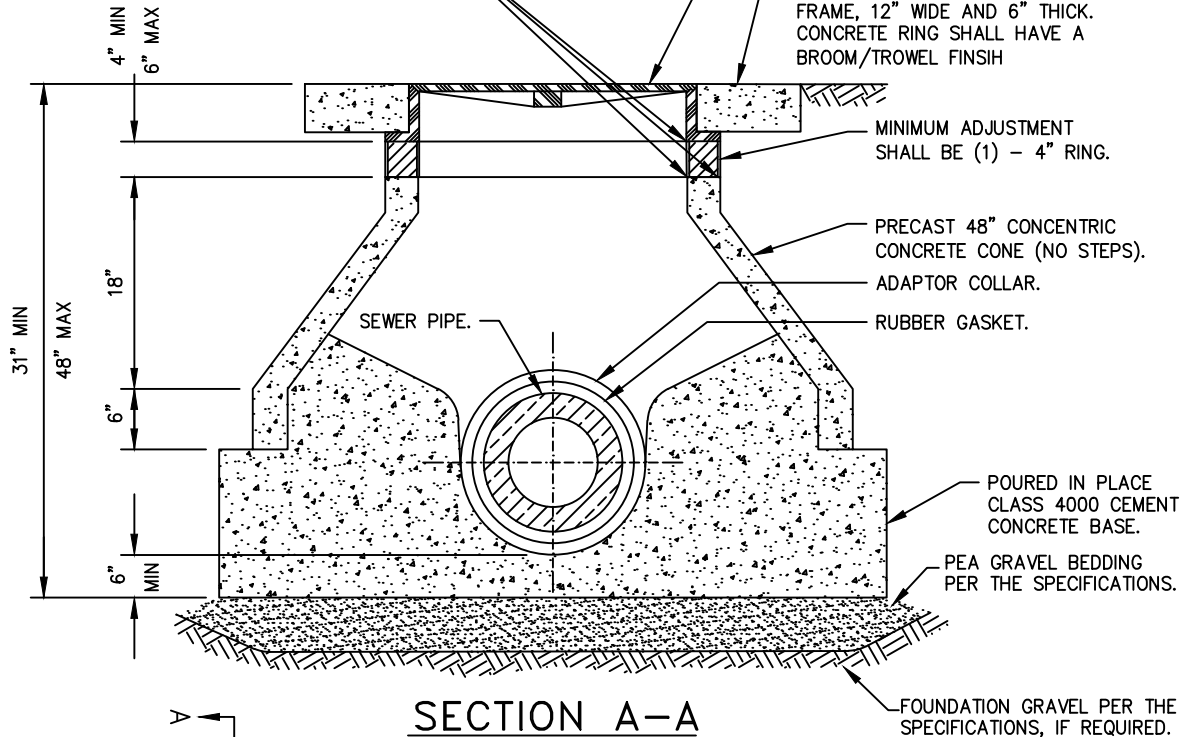

SECTION A-A

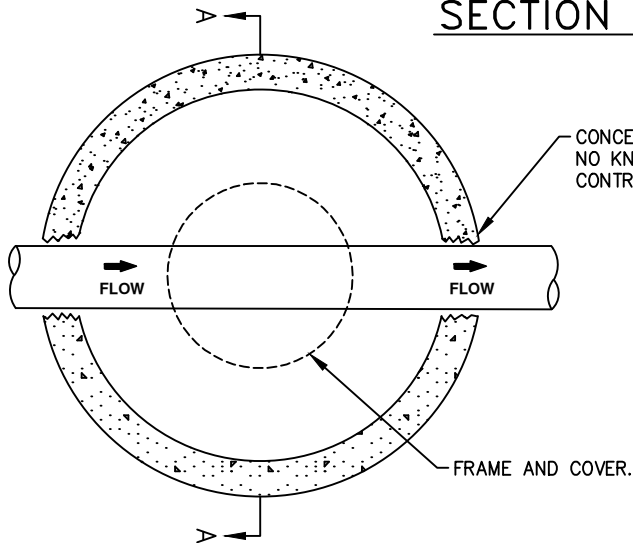

PLAN

NOTES:

1. APPLY RAVEN 405 EPOXY COATING, PER MANUFACTURER'S RECOMMENDATION, TO CHANNEL, SHELF, AND CONE SECTION. ENSURE INSIDE OF MANHOLE IS CLEAN AND DRY PRIOR TO COATING.
2. MARKER POSTS MAY BE REQUIRED IN EASEMENTS.
3. ALL PICK HOLES SHALL BE GROUTED ON THE INSIDE AND OUTSIDE OF MANHOLE.
4. MANHOLE LID SHALL BE ORIENTED PER THE DISTRICT'S DIRECTION.

EXTRA SHALLOW SADDLE MANHOLE

NOT TO SCALE

DETAIL APPROVALS
EDITOR TMC
MANAGER SJD

NORTHSHORE UTILITY DISTRICT
2023 STANDARD SEWER DETAILS

16

LAST UPDATED
 FEBRUARY 2020